

CRT 20B

Colour sensors

Part No. 50109619



12.5mm
60mm



- Scanner for colour detection
- Very short response time $\geq 85\mu s$ for detection of fast or small objects and marks
- Direct indication of colour quality by means of bargraph display
- Simultaneous selection of up to 4 colours
- Teach-in via buttons or control line
- Temperature compensation for reproducible colour detection

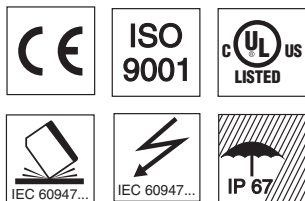

Accessories:

(available separately)

- Cable with M12 connector, 5-pin
- Cable with M12 connector, 8-pin
- Reflectors

Dimensioned drawing

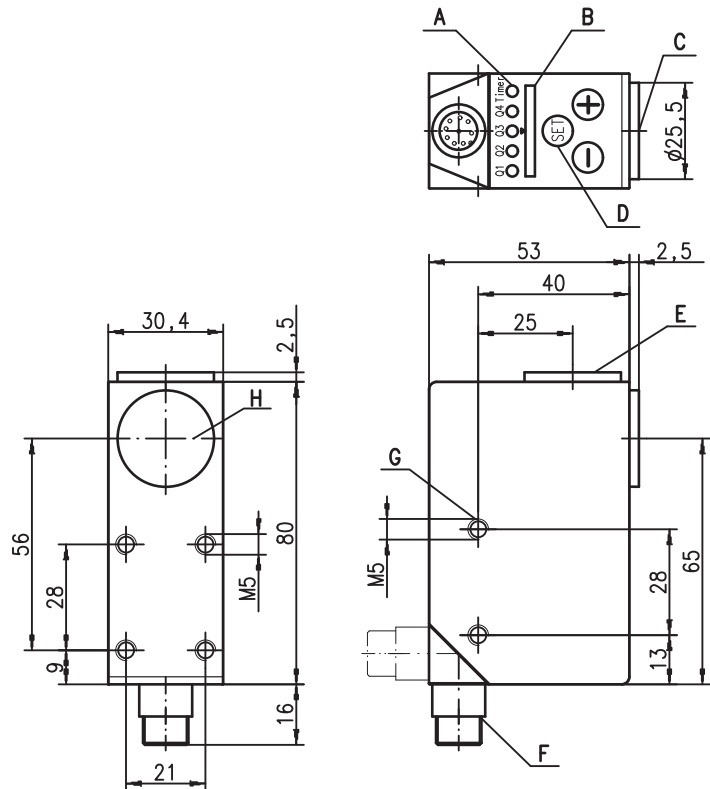

- A Function indicator (yellow)
- B Bargraph display (green), Power On = left LED
- C Dimensioned drawing of the objective
- D Teach-in button, '+' and '-' buttons
- E Dummy screw fitting, interchangeable with H
- F 90° turning connector
- G Mounting thread M5 – 5.5mm deep
- H Objective (light beam gate)

Electrical connection

CRT 20B M/P...001-S12

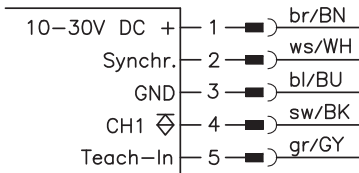

CRT 20B M/N...001-S12

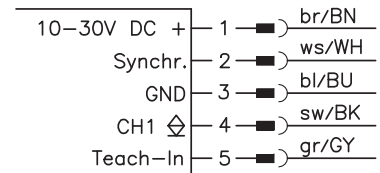

CRT 20B M/P...004-S12

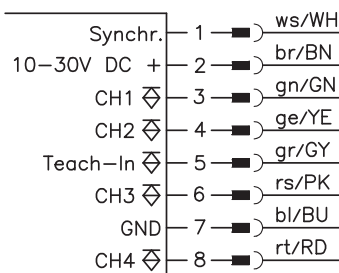

CRT 20B M/N...004-S12

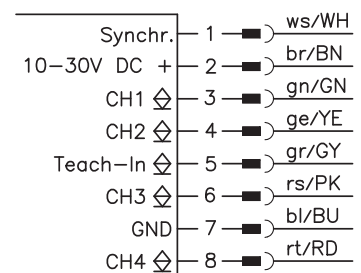

We reserve the right to make changes *fmt_crt03gb.fm

Specifications

Optical data

Scanning range (see remarks)
 Light spot dimensions (in scanning range)
 Operating range with reflector ¹⁾
 Light spot orientation
 Light source²⁾
 Wavelength

Objective 1

12.5mm ± 3mm
 4.0mmx2.0mm
 100 ... 250mm
 vertical
 LEDs (red, green, blue)
 640nm, 525nm, 470nm

Objective 2

60mm ± 9mm
 13.0mmx13.0mm
 250 ... 1000mm

Timing

Switching frequency ³⁾
 Response time ³⁾
 Delay before start-up
 Storage time

adjustable: 1 kHz, 3kHz, 6kHz
 adjustable: 500µs, 160µs, 85µs
 ≤ 500ms
 25ms, non-volatile storage

CRT 20B...-004

0.5kHz, 1kHz, 3.5kHz
 1 ms, 500µs, 145µs

Electrical data

Operating voltage U_B
 Residual ripple⁴⁾
 Switching output

10 ... 30VDC (incl. residual ripple)
 ≤ 15% of U_B
 1x PNP / 1x NPN
 (for one colour assignment) 4x PNP / 4x NPN
 (for four colour assignments)

Function characteristics
 Signal voltage high/low

light/dark switching for all outputs
 PNP: $\geq (U_B - 2V)/0V$
 NPN: $U_B \leq 2V$
 max. 120mA per output
 ≤ 80mA

Output current
 Open-circuit current

Indicators

Q LED(s) - yellow
 Timer LED - yellow
 Bargraph display LEDs - green

Q: object 1 detected Q1-Q4: object 1-4 detected
 timer activated
 left LED = Power On
 remaining LEDs = colour value display

Mechanical data

Housing
 Optics cover
 Weight
 Connection type

diecast zinc
 glass
 approx. 400g
 M12 connector, 5-pin M12 connector, 8-pin

Environmental data

Ambient temp. (operation/storage)
 Protection class
 LED class
 VDE safety class ⁵⁾
 Protective circuit ⁶⁾
 Standards applied
 Certifications

-10°C ... +55°C/-25°C ... +75°C
 IP 67
 1 (acc. to EN 60825-1)
 II, all-insulated
 2, 3
 IEC 60947-5-2
 UL 508 ⁷⁾

Options

Teach-in input

PNP: Teach-in / Run
 NPN: Teach-in / Run
 Teach duration

> 10V ... ≤ $U_B / 0V$ or not connected
 ≤ 2V / U_B or not connected
 > 2ms

Synchronous input

PNP: Stop/Start measurement
 NPN: Stop/Start measurement
 Synchronisation delay

> 10V ... ≤ $U_B / 0V$ or not connected
 ≤ 2V / U_B or not connected
 > 0,2ms

Pulse stretching ⁸⁾

20ms, can be switched on

- 1) With reflector TKS 100x100
- 2) Average life expectancy 100,000h at an ambient temperature of 25°C
- 3) With light-dark ratio 1:1
- 4) Must lie within $U_B \pm$ tolerance
- 5) Rating voltage 50VDC
- 6) 2=polarity reversal protection, 3=short-circuit protection for all outputs
- 7) For UL applications: for use in class 2 circuits according to NEC only
- 8) Relative to object

Order guide

See section **Preferred types**

Tables

Diagrams

Remarks

- **Approved purpose:**
 The CRT 20B colour sensors are optoelectronic sensors and are used for optical, contactless detection of coloured objects with incident light (scanner operation) and transmitted light (reflector operation). A reflector is necessary for operation in transmitted light.
- With shiny objects, the sensor is to be mounted at an angle of approx. 10 ... 30° to the object surface.

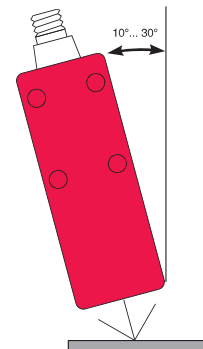

Function principle of the colour sensor

Many sensors are capable of differentiating between light and dark or matt and shiny. As soon as colour is to serve as a distinguishing criterion, however, normal sensors are quickly pushed to their limits.

As a result, colour sensors are of increasing importance in industrial automation.

The applications range from sorting coloured objects to the detection or inspection of coloured surfaces. Materials such as powders, granulates, fluids as well as metals, glasses, papers, plastics and textiles can be reliably detected in this way.

Simple operation makes it possible to teach-in the reference colour and to adjust the tolerance range.

During operation, the colour sensor compares the taught-in colour with the measured colour. If the values lie within the set tolerance range, the sensor passes on the match to the controller via a switching output.

Controls and indicators

CRT 20B...001

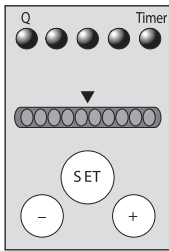

CRT 20B...004

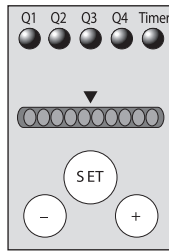

Function indicator LEDs Q/timer (yellow)

Bargraph display (green), Power On = left LED on

Teach-in button (SET), "+" and "-" buttons

Operation

During operation, the bargraph display indicates the colour quality, i.e. the degree of matching with the taught colour (with the CRT 20B...004 according to the selected colour channel, see Special settings). If above or below the arrow, the switching output changes its state.

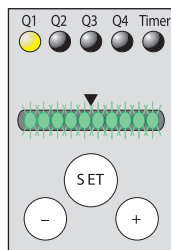

Full match
Colour detected
Switching output active

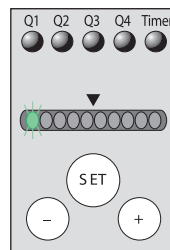

No match
Colour not detected
Switching output not active

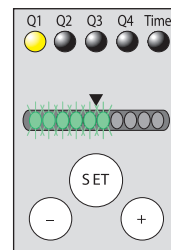

Tolerance edge
Colour detected
Switching output active





The colour tolerance can be readjusted during operation:

- To do this, press the "+" button and release after > 1 s.
- Then use "+" or "-" to adjust the tolerance
- Confirm with "SET"



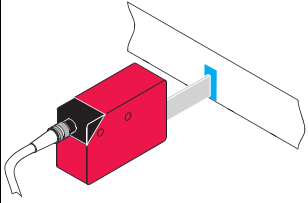

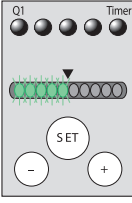

This function can be switched on and off in the special settings (see "Tolerance adjustable during operation"). With the CRT 20B...004, the tolerance refers to the selected channel (see "Quality indicator during operation" under Special settings).

Teach-in of the switching threshold

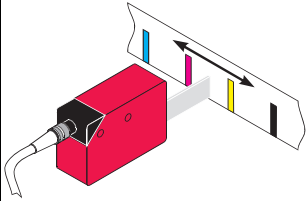
With the CRT 20B...001:

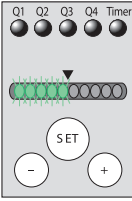
<p>Position colour</p> 	<p>Press SET > 1 s and release</p>  <p>> 1 s</p>	<p>Adjust tolerance with "+" or "-"</p> 	<p>Briefly press SET to confirm</p> 
--	---	---	---

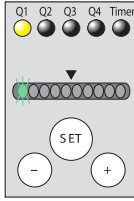
With the CRT 20B...004:

<p>Position colour</p> 	<p>Press SET > 1 s and release</p>  <p>> 1 s</p>	<p>Adjust tolerance with "+" or "-"</p> 	<p>Briefly press SET to confirm</p> 	<p>Select channel with "+" or "-"</p> 	<p>Briefly press SET to confirm</p> 
--	---	---	---	---	---

The teach event must be repeated for each colour that is to be taught. Each colour must be assigned its own channel (Q1-Q4). Alternatively, the teach-in can also be performed via the teach line. The tolerance setting is not performed in this case. With the CRT 20B...004, only channel Q1 is set via the line teach.

Special settings

- Simultaneously press the "+" and "-" buttons > 1 s to enter and exit. Active special settings are indicated by flashing of one or more of the Q-LEDs.
- Use "+" or "-" to navigate / make settings
- Use "SET" to select / confirm
- Simultaneously press the "+" and "-" buttons > 5 s to reset to factory settings.

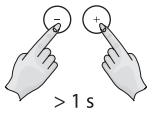

Operating mode

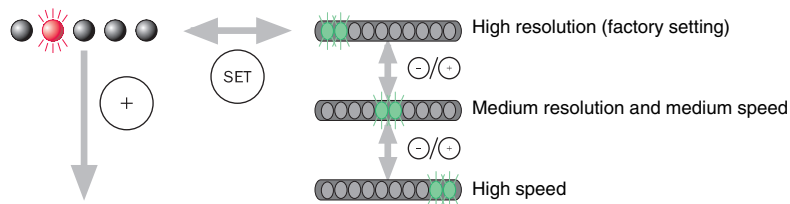

Tolerance adjustable during operation

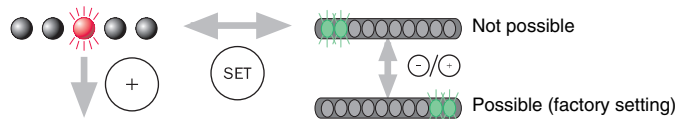

Quality indicator during operation (CRT 20B...001)

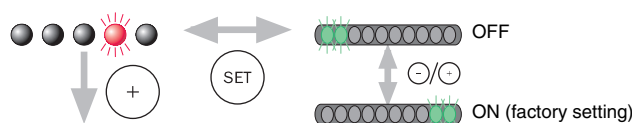

Quality indicator during operation (CRT 20B...004)

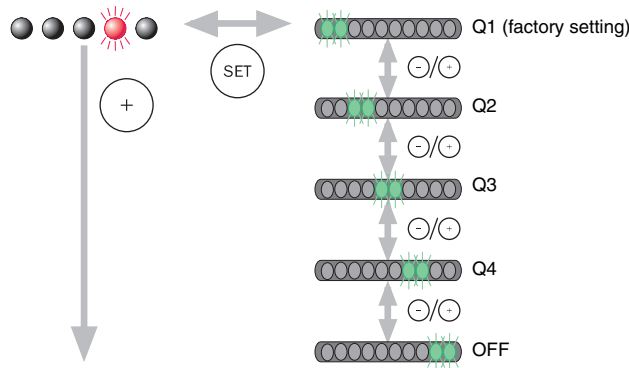

Switching delay

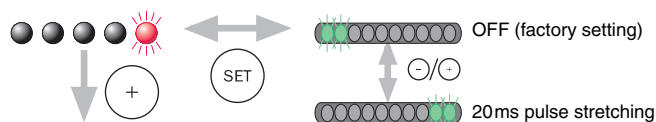

Output logic

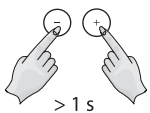
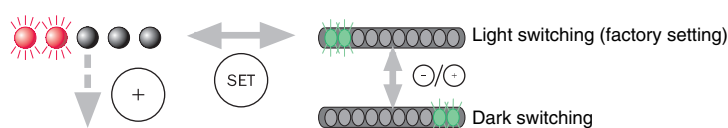

Preferred types

Selection table		Order code →							
Equipment ↓		CRT 20B M/N-12-001-S12 Part No. 501 09594	CRT 20B M/N-60-001-S12 Part No. 501 09595	CRT 20B M/P-12-001-S12 Part No. 501 09596	CRT 20B M/P-60-001-S12 Part No. 501 09597	CRT 20B M/N-12-004-S12 Part No. 501 09598	CRT 20B M/N-60-004-S12 Part No. 501 09599	CRT 20B M/P-12-004-S12 Part No. 501 09600	CRT 20B M/P-60-004-S12 Part No. 501 09601
Scanning range	12,5mm	●		●		●		●	
	60mm		●		●		●		●
Light spot size	4mm x 2mm	●		●		●		●	
	13mm x 13mm		●		●		●		●
Light spot orientation	vertical	●	●	●	●	●	●	●	●
	horizontal								
Optical outlet	front								
	head	●	●	●	●	●	●	●	●
Switching output	1x PNP			●	●				
	1x NPN	●	●						
	4x PNP							●	●
	4x NPN					●	●		
M12 connector	5-pin	●	●	●	●				
	8-pin					●	●	●	●
Adjustment	Teach-in via control buttons	●	●	●	●	●	●	●	●
	Teach-in via line	●	●	●	●	●	●	●	●
Options	synchronisation via line	●	●	●	●	●	●	●	●
	20ms pulse stretching	●	●	●	●	●	●	●	●
	light/dark switching for all outputs	●	●	●	●	●	●	●	●

Additional types on request